

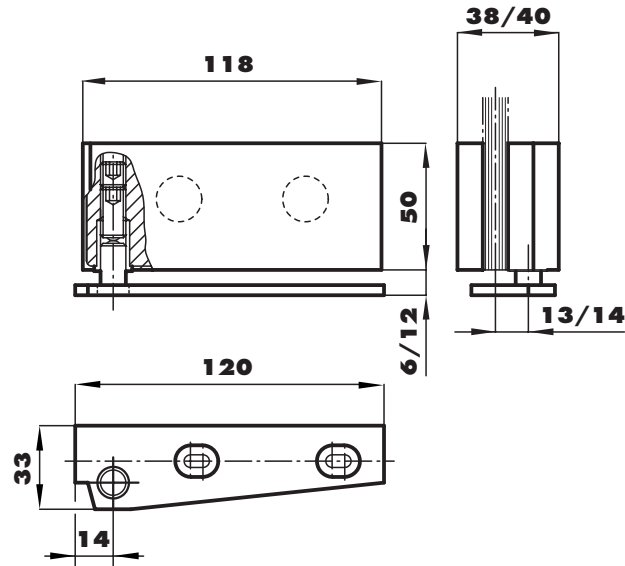

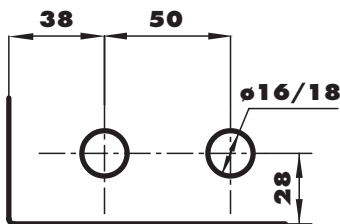















12790

T1.02



Available finishes - Finiture disponibili
Acabados disponibles

- 610 
- 611 
- 612 
- 613 
- 614 
- 615 
- 620 
- 632 
- 633 
- Ral 
- 710 
- 711 
- 712 
- 713 
- 715 
- 810 
- 812 

Technical characteristics - Caratteristiche tecniche - Características técnicas

Glass thickness	Spessore vetro	Espesor del vidrio	mm 8/10
Max. door weight	Peso massimo della porta	Peso máximo de la puerta	kg 60
Max. door width	Larghezza massima della porta	Ancho máximo de la puerta	mm 1000
Recommended torque for fixing screws	Coppia di serraggio raccomandata per viti di fissaggio	Momento del cerramiento aconsejado para tornillos	Nm 14÷16
Glass holding power	Resistenza allo sfilamento del vetro	Agarre sobre el vidrio	kg > 160
Average item weight	Peso medio dell'articolo	Peso medio del artículo	kg 0,9

NOTES - NOTE - ANOTACIONES