

16090

Z-1885

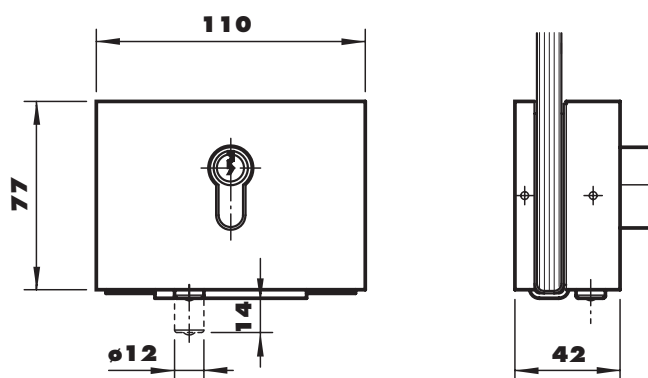

Available finishes - Finiture disponibili
Acabados disponibles

- 610
- 611
- 612
- 613
- 614
- 615
- 620
- 632
- 633
- Ral
- 710
- 711
- 712
- 713
- 715
- 810
- 812

Technical characteristics - Caratteristiche tecniche - Características técnicas

Glass thickness	Spessore vetro	Espesor del vidrio	mm 10
Max. door weight	Peso massimo della porta	Peso máximo de la puerta	
Max. door width	Larghezza massima della porta	Ancho máximo de la puerta	
Recommended torque for fixing screws	Coppia di serraggio raccomandata per viti di fissaggio	Momento del cerramiento aconsejado para tornillos	8÷9 Nm
Glass holding power	Resistenza allo sfilamento del vetro	Agarre sobre el vidrio	kg > 50
Average item weight	Peso medio dell'articolo	Peso medio del artículo	kg 0,86

NOTES - NOTE - ANOTACIONES

Without glass cutouts

Senza lavorazione sul vetro

Sin muescas en el vidrio

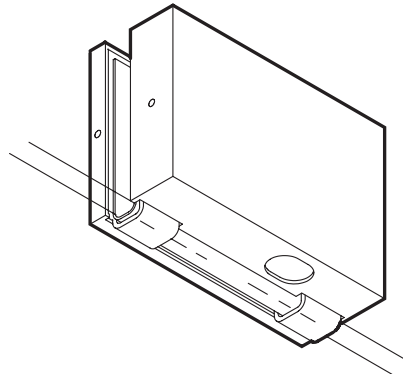
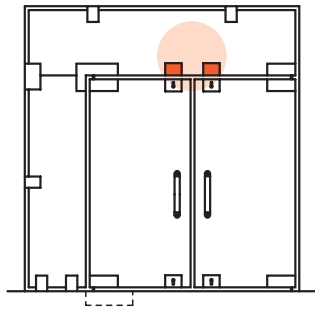





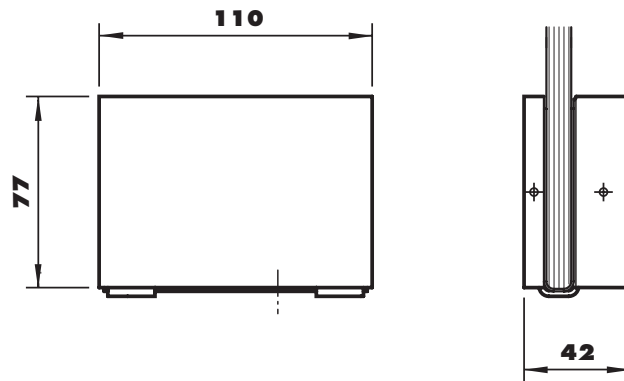











16190

ZB-1885



Available finishes - Finiture disponibili
Acabados disponibles

- 610 
- 611 
- 612 
- 613 
- 614 
- 615 
- 620 
- 632 
- 633 
- Ral 
- 710 
- 711 
- 712 
- 713 
- 715 
- 810 
- 812 

Technical characteristics - Caratteristiche tecniche - Características técnicas

Glass thickness	Spessore vetro	Espesor del vidrio	mm 10
Max. door weight	Peso massimo della porta	Peso máximo de la puerta	
Max. door width	Larghezza massima della porta	Ancho máximo de la puerta	
Recommended torque for fixing screws	Coppia di serraggio raccomandata per viti di fissaggio	Momento del cerramiento aconsejado para tornillos	Nm 8÷9
Glass holding power	Resistenza allo sfilamento del vetro	Agarre sobre el vidrio	kg > 50
Average item weight	Peso medio dell'articolo	Peso medio del artículo	kg 0,60

NOTES - NOTE - ANOTACIONES

Without glass cutouts

Senza lavorazione sul vetro

Sin muescas en el vidrio