



www.shai-shick.co.il
SHAI SHICK





 Larghezza max dell' anta
 Max door width
 Ancho de la puerta
1000 mm
 39-3/8"

 Spessore vetro
 Glass thickness
 Espesor del vidrio
8 ÷ 14 mm
 5/16 ÷ 9/16"

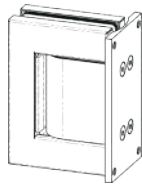

 Kg
 Peso max
 Door weight
 Peso máximo
100 kg
 220Lbs

 Testata
 Tested
 Testado
500.000 cicli
 cycle - ciclos





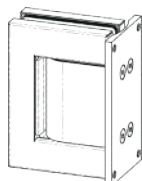





4LC1S
 Cerniera idraulica chiudiporta
 Hydraulic hinge
 Bisagra hidráulica



4LCDS
 Cerniera libera
 Dummy hinge
 Bisagra libre



Finiture
 Finishing
 Acabados

	
610	611
	
613	710
	
614	712
	
615	810
	
620	812

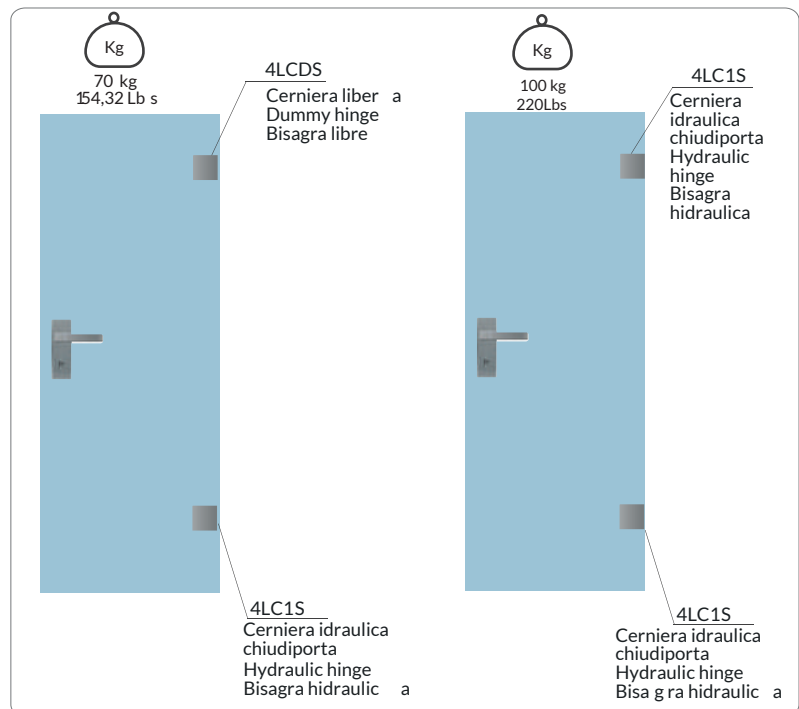

LATUS

Cerniera idraulica chiudiporta
Hydraulic hinge
Bisagra hidráulica

Cod. 4LCXS

Applicazione vetro-muro con aletta centrale
Glass to wall application with central wing
Aplicación vidrio-pared con aleta central

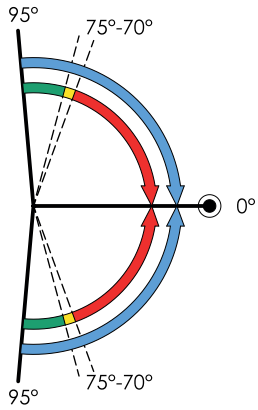

- Possibile posizione della porta
Possible door position
Posible posición de la puerta
- Chiusura controllata
Self-closing
Cierre controlado
- Avvio chiusura controllata
Start closing
Inicio cierre controlado
- Posizione libera
Free standing
Posición libre
- Stop

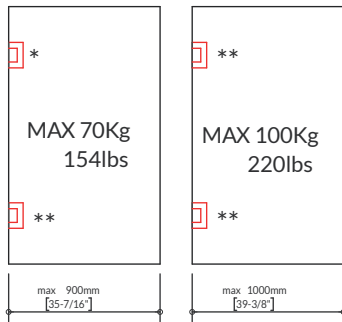
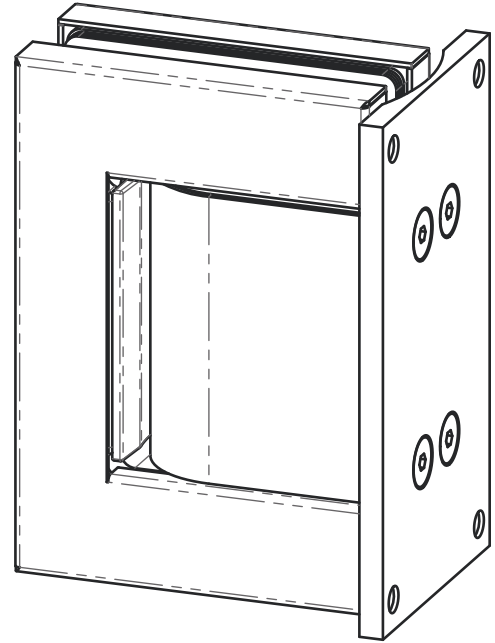

* **4LCDS**
Cerniera libera
Dummy hinge
Bisagra libre

** **4LC1S**
Cerniera idraulica
Hydraulic hinge
Bisagra hidráulica

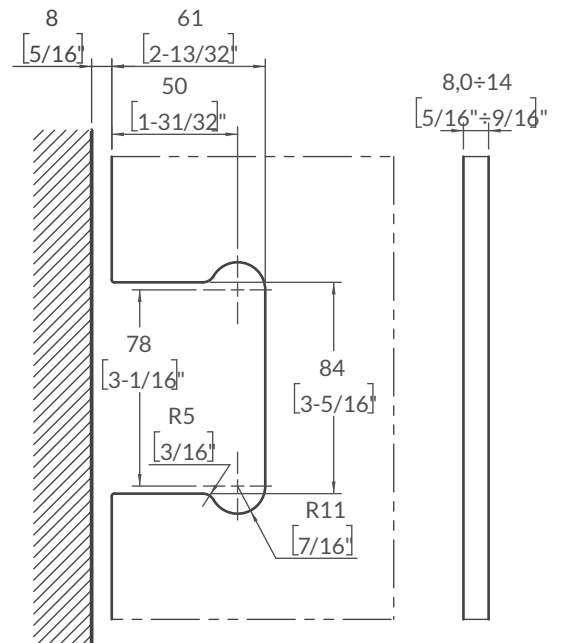
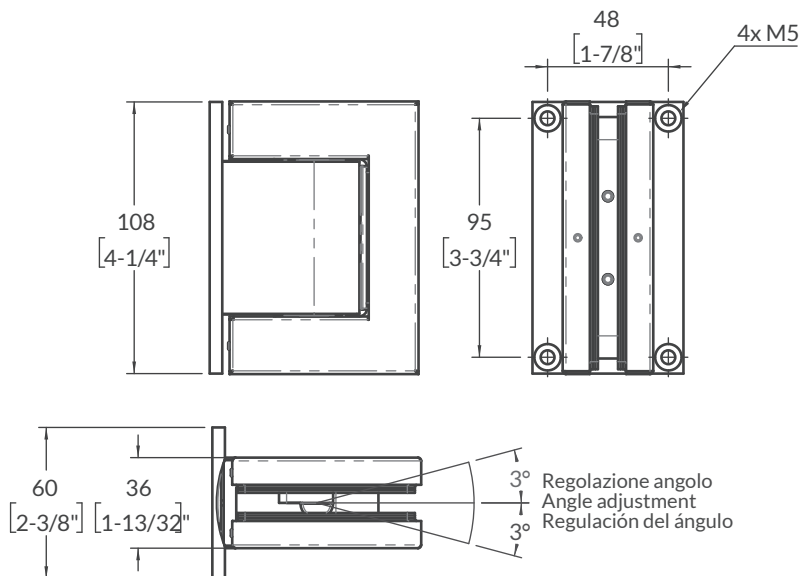

+/- Regolazione velocità
Speed adjustment
Regulación de velocidad

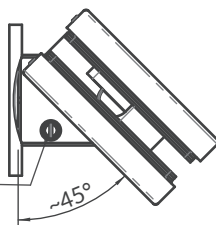

Applicazione vetro-muro con aletta decentrata
 Glass to wall application with off-set wing
 Aplicación vidrio-pared con aleta desplazada





 Larghezza max dell'anta
 Max door width
 Ancho de la puerta
 1000 mm
 39-3/8"

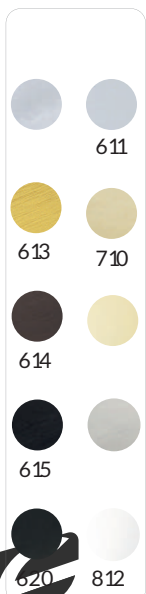

 Spessore vetro
 Glass thickness
 Espesor del vidrio
 8 ÷ 14 mm
 5/16 ÷ 9/16"

 Peso max
 Door weight
 Peso máximo
 100 kg
 220Lbs



 Testata
 Tested
 Testado
 500,000 cicli
 cycle - ciclos

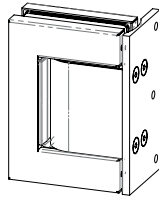

4LL1S
 Cerniera idraulica chiudiporta
 Hydraulic hinge
 Bisagra hidráulica

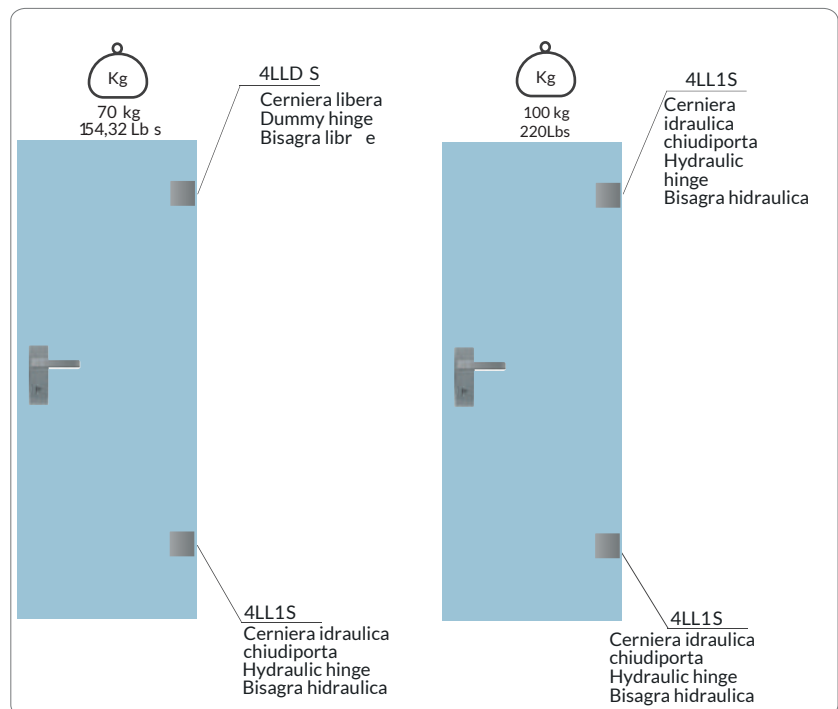
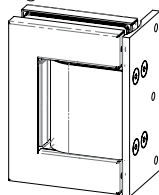

4LLD S
 Cerniera libera
 Dummy hinge
 Bisagra libre



LATUS

Cerniera idraulica chiudiporta
Hydraulic hinge
Bisagra hidráulica

Cod. 4LLXS

Applicazione vetro-muro con aletta decentrata
Glass to wall application with off-set wing
Aplicación vidrio-pared con aleta desplazada

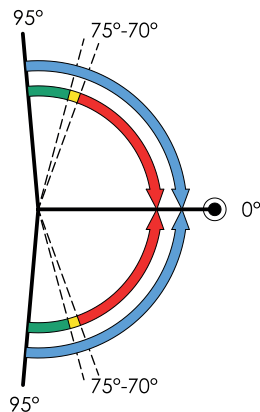
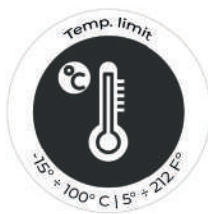

- Possibile posizione della porta
Possible door position
Posible posición de la puerta
- Chiusura controllata
Self-closing
Cierre controlado
- Avvio chiusura controllata
Start closing
Inicio cierre controlado
- Posizione libera
Free standing
Posición libre
- Stop

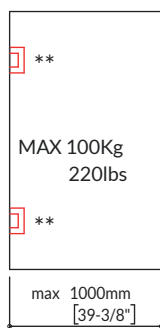
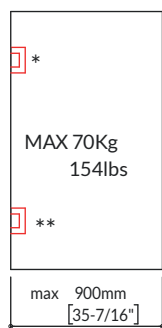
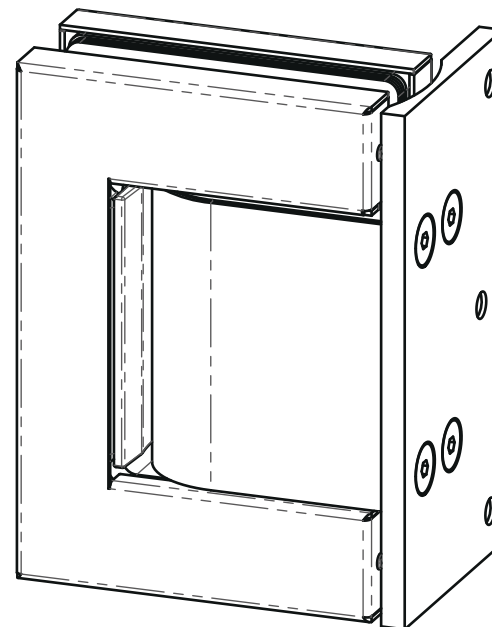

* **4LLDS**
Cerniera libera
Dummy hinge
Bisagra libre

** **4LL1S**
Cerniera idraulica
Hydraulic hinge
Bisagra hidráulica

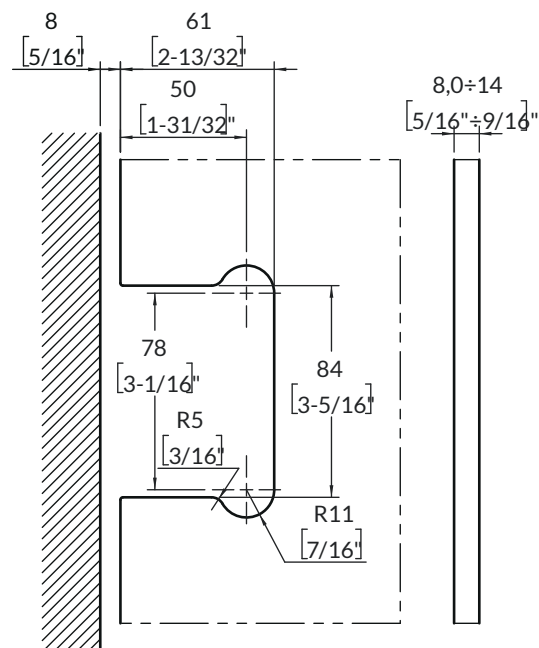
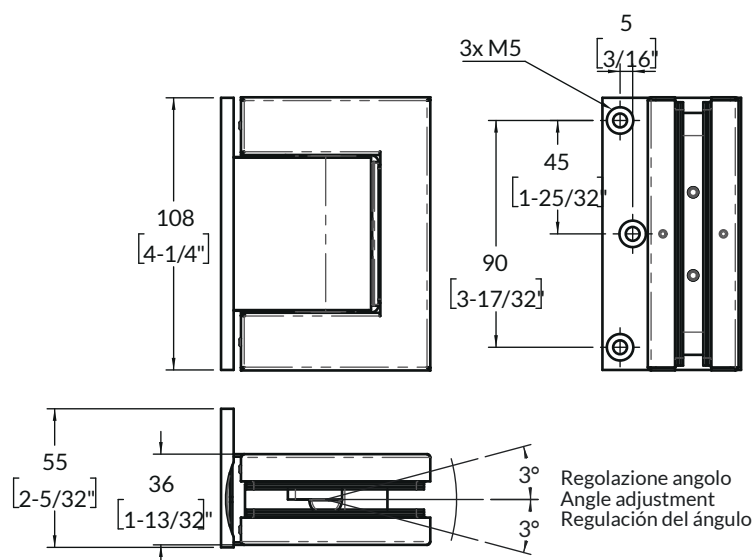

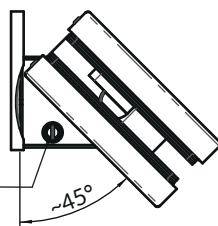

+/- Regolazione velocità
Speed adjustment
Regulación de la velocidad















 Larghezza max dell'anta
 Max door width
 Ancho de la puerta
1000 mm
 39-3/8"



 Spessore vetro
 Glass thickness
 Espesor del vidrio
8 ÷ 14 mm
 5/16 ÷ 9/16"

 Peso max
 Door weight
 Peso máximo
100 kg
 220Lbs

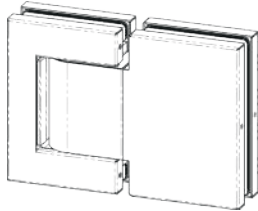

 Testata
 Tested
 Testado
500.000 cicli
 cycle - ciclos

- Finiture**
 Finishing
 Acabados
-   610 611
 -   613 710
 -   614 712
 -   615 810
 -   620 812

4LVIS
 Cerniera idraulica chiudiporta
 Hydraulic hinge
 Bisagra hidráulica

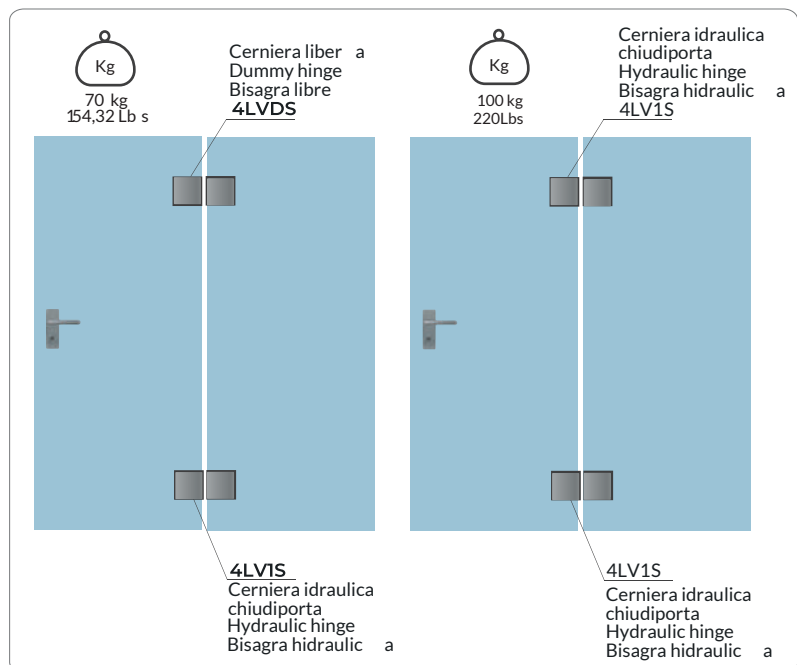
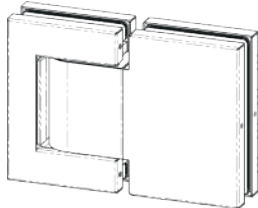

4LVDS
 Cerniera libera
 Dummy hinge
 Bisagra libre



LATUS

Cerniera idraulica chiudiporta
Hydraulic hinge
Bisagra hidráulica



www.shai-shick.co.il
SHAI SHICK
CONSULTING AND IMPORT COMPANY LTD.

Cod. 4LVXS

Applicazione vetro-vetro
Glass to glass application
Aplicación vidrio-vidrio

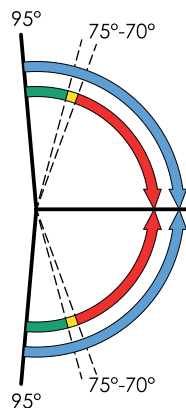
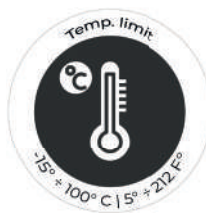

- Possibile posizione della porta
Possible door position
Posible posición de la puerta
- Chiusura controllata
Self-closing
Cierre controlado
- Avvio chiusura controllata
Start closing
Inicio cierre controlado
- Posizione libera
Free standing
Posición libre
- Stop

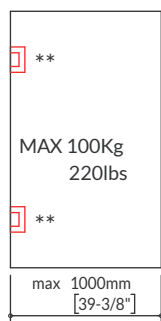
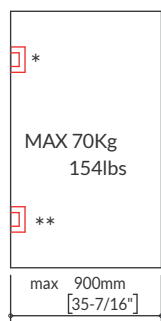
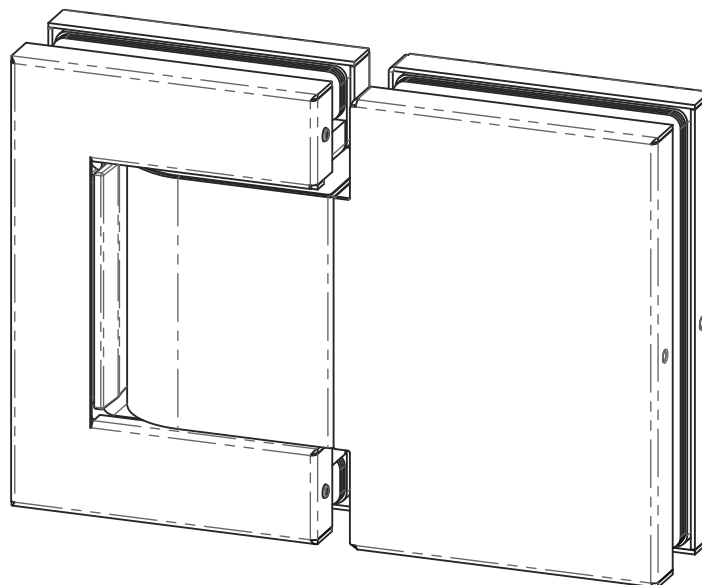

* 4LVDS
Cerniera libera
Dummy hinge
Bisagra libre

**4LV1S
Cerniera idraulica
Hydraulic hinge
Bisagra hidráulica

